

**Flat Connectors 2.8 mm**

**Flachstecktechnik 2,8 mm**

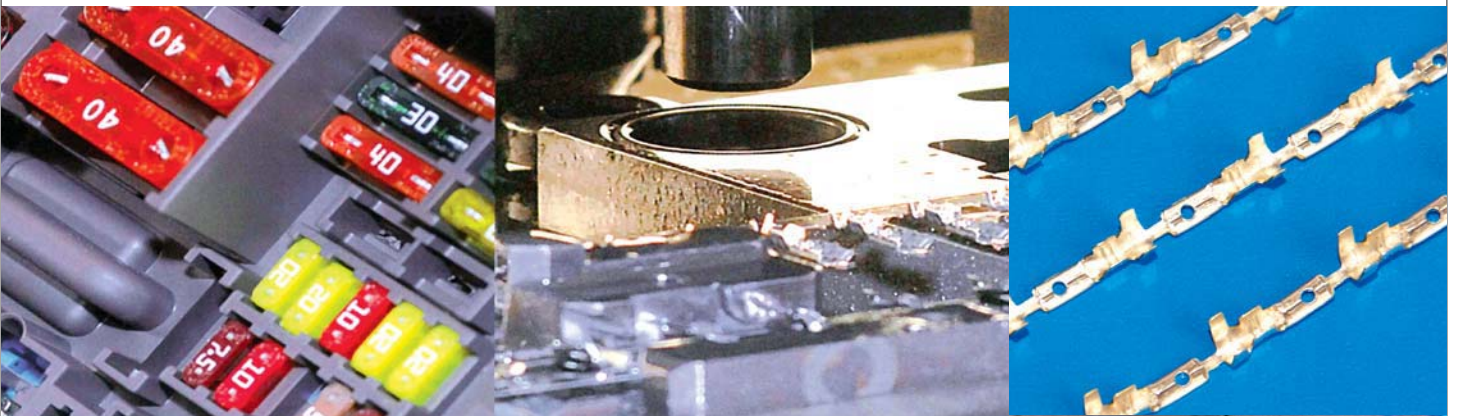

**Receptacles**  
for tab width 2.8 mm  
DIN 46330 and similar types

**Flachsteckhülsen**  
für Steckerbreite 2,8 mm  
DIN 46330 und ähnliche Ausführungen

Type 1

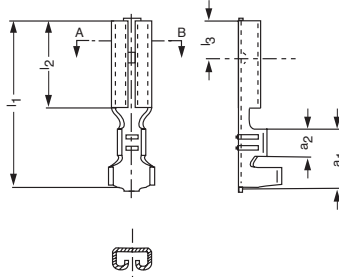

Schnitt A-B

Type	Wire cross section qmm	Tab thickness	Tab width	DIN standard	Nominal size	a1	a2	l1	l2	l3	Material thickness	Notch	Form E=Single B=chain	Part number	Material	Surface	Terminal feed	Foot-note
1	0.1 - 0.25	0.80	2.8			5.00	2.00	14.00	6.30	3.30	0.25	X	B B	<b>25325.123.211</b> <b>25325.213.011</b>	CuZn CuSn	Sn Sn		L
1	0.1 - 0.3	0.80	2.8	46330 Teil 2 Form A	2.8 - 0.25	5.00	2.00	12.50	5.00	3.90	0.25	X	B B	<b>25548.123.204</b> <b>25548.123.211</b>	CuZn CuZn	Sn		L
1	0.1 - 0.3	0.50	2.8			5.00	2.00	14.00	6.30	5.50	0.25	X	B	<b>25621.123.211</b>	CuZn	Sn		L
1	0.1 - 0.25	0.50	2.8			5.00	2.00	12.50	5.00	3.90	0.25	X	B	<b>25682.123.211</b>	CuZn	Sn		L *1
1	0.3 - 0.6	0.80	2.8			5.70	3.20	14.00	6.30	3.30	0.25	X	B B	<b>25837.123.204</b> <b>25837.123.211</b>	CuZn CuZn	Sn		L
Typ	Nenn-quer-schnitt qmm	Steck-dicke	Steck-breite	DIN	Nenn-größe	a1	a2	l1	l2	l3	Mat.-dicke	Stahl-feder	Form E=Einzel B=Band	Teile-Nr.	Werkstoff	Oberfläche	Verb.-vor-schub	Fuß-note

\*1 For wires DIN 47104 - E or solid wire 18 x 0.1 mm

\*1 Für Leitungen DIN 47104 - E und Drahtlitzleiter 18 x 0,1 mm

Einzelkontakte auf Anfrage



**Receptacles**  
for tab width 2.8 mm  
DIN 46247 and similar types

**Flachsteckhülsen**  
für Steckerbreite 2,8 mm  
DIN 46247 und ähnliche Ausführungen

Type 1

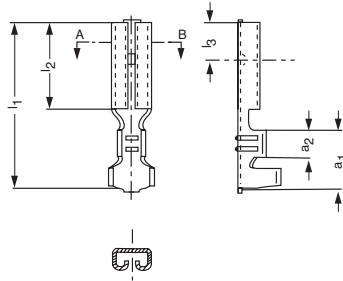

Schnitt A-B

Type	Wire cross section qmm	Tab thickness	Tab width	DIN standard	Nominal size	a1	a2	l1	l2	l3	Material thickness	Notch	Form E=Single B=chain	Part number	Material	Surface	Terminal feed
1	0.5 - 1.0	0.50	2.80			5.00	2.80	12.50	5.00	3.30	0.30	X	B B	<b>25029.123.211</b> <b>25029.213.011</b>	CuZn CuSn	Sn Sn	L
1	0.5 - 1.0	0.8	2.80			5.50	2.50	15.50	8.00		0.30	X	B	<b>25414.417.031</b>	Stahl	Ni	L
1	0.5 - 1.0	0.50	2.80	46247 Teil 1 Form A	2.8 - 1	5.50	2.50	14.00	6.30	3.30	0.25	X	B B B	<b>25415.123.204</b> <b>25415.123.211</b> <b>25415.213.011</b>	CuZn CuZn CuSn	Sn Sn	L
1	0.5 - 1.0	0.40	2.80			5.00	2.80	12.50	5.00	3.30	0.30	X	B	<b>25462.123.211</b>	CuZn	Sn	L
1	0.5 - 1.0	0.80	2.80			5.50	2.50	14.00	6.30	5.30	0.25	X	B	<b>25516.123.211</b>	CuZn	Sn	L
1	0.5 - 1.0	0.50	2.80			5.50	2.50	14.00	6.30	5.30	0.25	X	B	<b>25789.123.211</b>	CuZn	Sn	L
Typ	Nennquerschnitt qmm	Steckdicke	Steckbreite	DIN	Nenngröße	a1	a2	l1	l2	l3	Mat.-dicke	Rastpunkt	Form E=Einzel B=Band	Teile-Nr.	Werkstoff	Oberfläche	Verb.-vor-schub

Einzelkontakte auf Anfrage



# Receptacles

for tab width 2.8 mm DIN 46247  
DIN 46330 and similar types

# Flachsteckhülsen

für Steckerbreite 2,8 mm DIN 46247  
DIN 46330 und ähnliche Ausführungen

Type 1

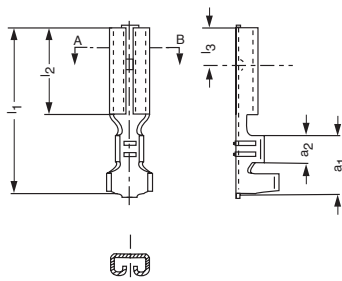

Schnitt A-B

Type	Wire cross section qmm	Tab thickness	Tab width	DIN standard	Nominal size	a1	a2	l1	l2	l3	Material thickness	Notch	Form E=single B=chain	Part number	Material	Surface	Terminal feed	Foot-note
1	0.5 - 1.0	0.80	2.80	46330 Teil 2 Form A	2.8 - 1	5.50	2.50	12.50	5.00	3.30	0.30	X	B B B B	25036.123.204 25036.123.211 25036.213.004 25036.417.031	CuZn CuZn CuSn ST4K40 RP	Sn   Ni	L	
1	0.5 - 1.0	0.80	2.80	46247 Teil 1 Form B	2.8 - 1	5.50	2.50	14.00	6.30	3.30	0.25	X	B B B B	25365.123.204 25365.123.211 25365.213.004 25365.213.011	CuZn CuZn CuSn CuSn	Sn  Sn	L	
1	0.75 - 1.5	0.8	2.80	46330 Teil 2 Form A	2.8 - 1.5	5.50	2.50	12.50	5.00	3.30	0.30	X	B	25562.123.211	CuZn	Sn	L	*1
1	0.75 - 1.5	0.50	2.80			5.50	2.50	12.50	5.00	3.30	0.30	X	B	25563.123.211	CuZn	Sn	L	*1
1	0.75 - 1.5	0.80	2.80			5.50	2.50	14.00	6.30	3.30	0.25	X	B	25572.123.211	CuZn	Sn	L	*1
1	0.75 - 1.5	0.40	2.80			5.50	2.50	14.00	6.30	3.30	0.25	X	B	26500.123.204	CuZn		L	*1
Typ	Nennquerschnitt qmm	Steckdicke	Steckbreite	DIN	Nenngröße	a1	a2	l1	l2	l3	Mat.-dicke	Rastpunkt	Form E=Einzel B=Band	Teile-Nr.	Werkstoff	Oberfläche	Verb.-vor-schub	Fuß-note

\*1 Provided for double crimp

\*1 Vorgesehen für Doppelcrimp

Einzelkontakte auf Anfrage



**Receptacles**  
for tab width 2.8 mm  
DIN 46330 and similar types

**Flachsteckhülsen**  
für Steckerbreite 2,8 mm  
DIN 46330 und ähnliche Ausführungen

Type 1

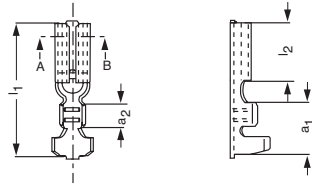

Schnitt A-B

Type 2

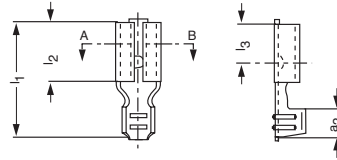

Schnitt A-B

Type	Wire cross section qmm	Tab thickness	Tab width	DIN standard	Nominal size	a1	a2	l1	l2	l3	Material thickness	Notch	Form E=Single B=chain	Part number	Material	Surface	Terminal feed	Foot-note
1	0.5 - 1.0	0.80	2.80			5.50	2.50	14.00	6.30		0.25		B	25103.123.204	CuZn		L	*1
2	0.5 - 1.0	0.80	2.80	46330 Teil 2 Form B	2.8 - 1		2.50	9.60	5.00	3.30	0.30	X	B B	25267.123.204 25267.123.211	CuZn CuZn	Sn	L	
2	0.5 - 1.0	0.50	2.80				2.50	9.60	5.00	3.30	0.30	X	B	25363.123.211	CuZn	Sn	L	
1	0.5 - 1.0	0.50	2.80			5.50	2.50	14.00	6.30		0.25		B	26110.123.211	CuZn		L	*1
Typ	Nenn-quer-schnitt qmm	Steck-dicke	Steck-breite	DIN	Nenn-größe	a1	a2	l1	l2	l3	Mat-dicke	Rast-punkt	Form E=Einzel B=Band	Teile-Nr.	Werkstoff	Oberfläche	Verb.-vor-schub	Fuß-note

\*1 Reduced insertion force

\*1 Steckkraftreduziert

Einzelkontakte auf Anfrage



**Receptacles**  
for tab width 2.8 mm  
Stator connecting terminals

**Flachsteckhülsen**  
für Steckerbreite 2,8 mm  
Mortoranschlußtechnik

Type 1

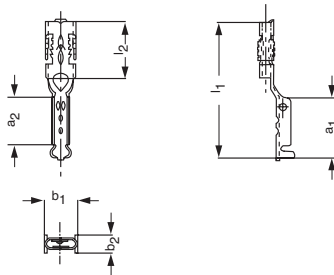

Type	Wire cross section qmm	Tab thickness	Tab width	a1	a2	b1	b2	l1	l2	Material thickness	Form E=single B=chain	Part number	Material	Surface	Terminal feed
1	0.3 - 0.6	0.80	2.80	7.00	5.50	3.60	2.15	15.25	6.25	0.30	B	25449.123.178	CuZn	Sn	L
Typ	Nennquerschnitt qmm	Steckdicke	Steckbreite	a1	a2	b1	b2	l1	l2	Mat.-dicke	Form E=Einzel B=Band	Teile-Nr.	Werkstoff	Oberfläche	Verb.-vor-schub

**Receptacles**  
for tab width 2.8 mm  
Stator connecting terminals

**Flachsteckhülsen**  
für Steckerbreite 2,8 mm  
Motoranschlußtechnik

Type 1

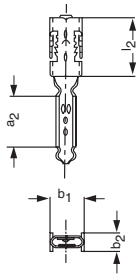

Type 2

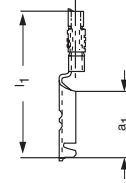
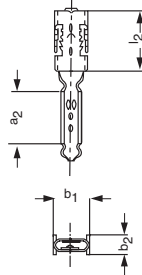
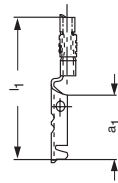

Type 3

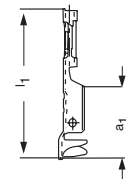
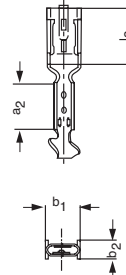

Type	Enameled wire diameter	Tab thickness	Tab width	a1	a2	b1	b2	l1	l2	Material thickness	Form E=single B=chain	Part number	Material	Surface	Terminal feed	Foot-note
1	0.3 - 0.6	0.80	2.80	7.00	5.50	3.60	2.15	15.50	6.25	0.30	B	<b>25831.213.009</b>	CuSn		SQ	*1
1	0.3 - 0.6	0.80	2.80	7.00	5.50	3.60	2.15	15.50	6.25	0.30	B	<b>25832.213.009</b>	CuSn		SQ	
2	0.3 - 0.6	0.80	2.80	7.00	5.50	3.60	2.15	15.50	6.25	0.30	B	<b>25893.213.009</b>	CuSn		SQ	*1
2	0.3 - 0.6	0.80	2.80	7.00	5.50	3.60	2.15	15.50	6.25	0.30	B	<b>25894.213.009</b>	CuSn		SQ	
3	0.4 - 0.75	0.80	2.80	8.20	5.25	3.60	1.60	16.40	6.25	0.30	B	<b>26198.213.009</b>	CuSn		NQ	
3	0.7 - 1.06	0.80	2.80	2.80	5.25	3.60	1.60	16.40	6.25	0.30	B	<b>26199.213.178</b>	CuSn	Sn	NQ	
Typ	Lackdraht-Ø	Steck-dicke	Steck-breite	a1	a2	b1	b2	l1	l2	Mat.-dicke	Form E=Einzel B=Band	Teile-Nr.	Werkstoff	Oberfläche	Verb.-vor-schub	Fuß-note

\*1 Side way feed right

\*1 Einlafrichtung in das Crimpwerkzeug von rechts



## Receptacles

for tab width 2.8 mm  
flag type

## Flachsteckhülsen

für Steckerbreite 2,8 mm  
mit seitlichem Leiteranschluß

Type 1

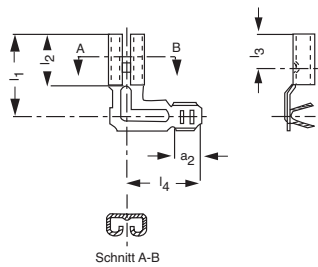

Type 2

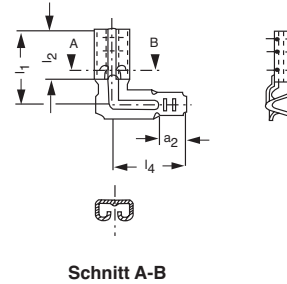

Type	Wire cross section qmm	Tab thickness	Tab width	a2	l1	l2	l3	l4	Material thickness	Notch	Form E=single B=chain	Part number	Material	Surface	Terminal feed
1	0.5 - 1	0.80	2.80	2.50	7.85	5.00	3.30	7.20	0.30	X	B B	25474.123.211 25474.213.011	CuZn CuSn	Sn Sn	L
2	0.5 - 1	0.50	2.80	2.50	7.85	5.00		7.20	0.30		B	25157.123.211	CuZn	Sn	L
Typ	Nenn-quer-schnitt qmm	Steck-dicke	Steck-breite	a2	b1	b2	l1	l2	Mat.-dicke	Rast-punkt	Form E=Einzel B=Band	Teile-Nr.	Werkstoff	Oberfläche	Verb.-vor-schub

**Receptacles**  
for tab width 2.8 mm  
to engage in housings  
DIN 46340 and similar types

**Flachsteckhülsen**  
für Steckerbreite 2,8 mm  
zum Einrasten in Gehäuse  
DIN 46340 und ähnliche Ausführungen

Type 1

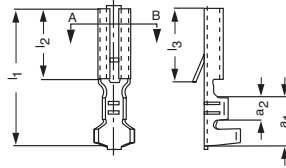

Schnitt A-B

Type	Wire cross section qmm	Tab thickness	Tab width	DIN standard	Nominal size	a1	a2	l1	l2	l3	Material thickness	Form E=Single B=chain	Part number	Material	Surface	Terminal feed	Footnote
1	0.1 - 0.25	0.80	2.8			5.00	2.00	14.00	6.30	5.60	0.25	B	26164.123.211	CuZn	Sn	L	*1
1	0.5 - 1.0	0.8	2.8	46340 Teil 1 Form B	2.8 - 1.0	5.50	2.50	14.00	6.30	5.60	0.25	B B B B	26365.123.204 26365.123.211 26365.213.004 26365.213.011	CuZn CuZn CuSn CuSn	Sn Sn	L	
1	0.5 - 1.0	0.5	2.8	46340 Teil 1 Form A	2.8 - 1.0	5.50	2.50	14.00	6.30	5.60	0.25	B B	26415.123.211 26415.213.011	CuZn CuSn	Sn Sn	L	
1	0.75 - 1.5	0.50	2.8			5.50	2.50	14.00	6.30	5.60	0.25	B	26504.123.211	CuZn	Sn	L	
1	0.75 - 1.5	0.80	2.8			5.50	2.50	14.00	6.30	5.60	0.25	B B B	26572.123.211 26572.213.004 26572.213.011	CuZn CuSn CuSn	Sn Sn	L	*2 *2 *2
Typ	Nennquerschnitt qmm	Steckdicke	Steckbreite	DIN	Nenngröße	a1	a2	l1	l2	l3	Mat. dicke	Form E=Einzel B=Band	Teile-Nr.	Werkstoff	Oberfläche	Verb.-vor-schub	Fußnote

\*1 For wires DIN 47104-E or solid wire 18 x 0.1 mm

\*2 Provided for double crimp

\*1 Für Leitungen DIN 47104-E oder Drahtlitzenleiter 18 x 0.1 mm

\*2 Vorgesehen für Doppelcrimp

Einzelkontakte auf Anfrage

**Receptacles**  
for tab width 2.8 mm  
stator connecting terminals

**Flachsteckhülsen**  
für Steckerbreite 2,8 mm  
Motoranschlußtechnik

Type 1

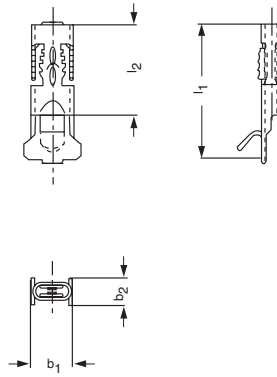

Type	Wire cross section qmm	Tab thickness	Tab width	b1	b2	l1	l2	Mat-erial thick-ness	Form E=single B=chain	Part number	Material	Surface	Ter-minal feed	Foot-note
1	0.2 - 0.5	0.60	2.8	3.60	2.15	10.60	7.20	0.30	B	25747.123.178	CuZn	Sn	NQ	*1
1	0.2 - 0.5	0.60	2.8	3.60	2.15	10.60	7.20	0.30	B	25748.123.178	CuZn	Sn	NQ	*2
Typ	Nenn-quer-schnitt qmm	Steck-dicke	Steck-breite	b1	b2	l1	l2	Mat.-dicke	Form E=Einzel B=Band	Teile-Nr.	Werkstoff	Oberfläche	Verb.-vor-schub	Fuß-note

\*1 Wound with welding hooks towards centre

\*2 Side way feed right, wound with welding hooks towards centre

\*1 Abspullage Schweißhaken zum Kern

\*2 Einlauf der Kontakte in das Crimpwerkzeug von rechts, Abspullage Schweißhaken zum Kern



## Receptacles

for tab width 2.8 mm  
Stator connecting terminals

## Flachsteckhülsen

für Steckerbreite 2,8 mm  
Motoranschlußtechnik

Type 1

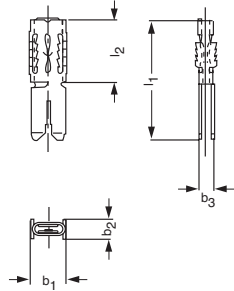

Type 2

Variante 1



Variante 2



Variante 3

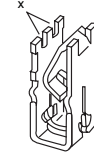

Type	Enameled wire diameter	Tab thickness	Tab width	b1	b2	b3	l1	l2	Material thickness	Form E=single B=chain	Part number	Material	Surface	Terminal feed	Foot-note
1	0.35 - 0.56	0.80	2.8	3.60	2.15	1.60	12.2	6.25	0.30	B	25147.123.178	CuZn	Sn	NQ	
1	0.63 - 0.85	0.80	2.8	3.60	2.15	1.60	12.2	6.25	0.30	B	25158.123.178	CuZn	Sn	NQ	
2	0.265 - 0.4	0.50	2.8						0.32	B	26796.202.009	CuSn	Sn		*2
2	0.4 - 0.67	0.50	2.8						0.40	B	26797.202.009	CuSn	Sn		*3
2	0.67 - 0.95	0.50	2.8						0.40	B	26797.202.178	CuSn	Sn		*3
2	0.67 - 0.95	0.50	2.8						0.40	B	26798.202.009	CuSn	Sn		*4
1	0.63 - 0.85	0.80	2.8	3.60	2.15	1.60	12.2	6.25	0.30	B	28050.123.178	CuZn	Sn	NQ	*1
Typ	Lackdraht- o	Steck- dicke	Steck- breite	b1	b2	b1	l1	l2	Mat.- dicke	Form E=Einze B=Band	Teile-Nr.	Werkstoff	Oberfläche	Verb- vor- schub	Fuß- note

\*1 Side way feed left

\*2 Version 2

\*3 Version 3

\*4 Version 4

\*1 Einlauf der Kontakte in das Verarbeitungswerkzeug von links

\*2 Variante 2

\*3 Variante 3

\*4 Variante 4

Type 1

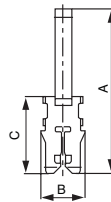

Type	A	B	C	Part number	Specification	Material	Surface
1	16.2	4.3	7.6	28189.202.179	SKL-D - Flachkontakt	CuSn4	FrSn 3+3
Typ	A	B	C	Teile-Nr.	Bezeichnung	Werkstoff	Oberfläche



## Tabs

for tab width 2.8 mm

## Flachstecker

für Steckerbreite 2,8 mm

Type 1

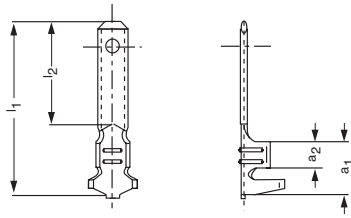

Type 2

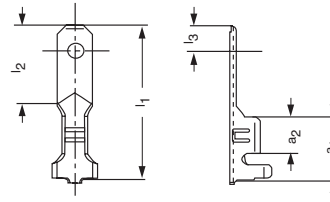

Type 3

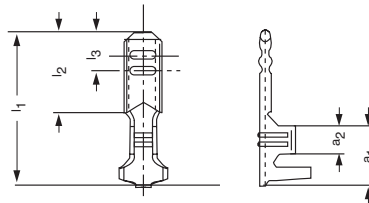

Type	Wire cross section qmm	Tab thickness	Tab width	a1	a2	l1	l2	l3	Material thickness	Form E=single B=chain	Part number	Material	Surface	Terminal feed
1	0.5 - 1.0	0.80	2.8	5.50	2.50	12.60	5.50		0.38	B B	<b>25144.123.009</b> <b>25144.123.111</b>	CuZn CuZn	Sn	L
3	0.3 - 0.8	0.80	2.8	5.20	2.40	13.20	6.60	3.10	0.38	B	<b>25829.123.009</b>	CuZn		NQ
3	0.3 - 0.8	0.80	2.8	5.20	2.40	24.20	17.60	3.10	0.38	B	<b>25830.123.009</b>	CuZn		NQ
2	0.3 - 0.6	0.50	2.8	5.50	3.20	13.20	6.00	2.20	0.38	B	<b>26709.123.179</b>	CuZn	Sn	NQ
Typ	Nennquerschnitt qmm	Steckdicke	Steckbreite	a1	a2	l1	l2	l3	Mat.-dicke	Form E=Einzel B=Band	Teile-Nr.	Werkstoff	Oberfläche	Verb.-vor-schub

Type 1

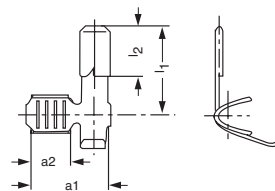

Type	Wire cross section qmm	Tab thickness	Tab width	a1	a2	l1	l2	Material thickness	Form E=single B=chain	Part number	Material	Surface	Terminal feed
1	0.75 - 1.5	0.80	2.8	7.50	4.00	8.00	4.75	0.38	B	<b>26218.123.179</b>	CuZn	Sn	L
Typ	Nennquerschnitt qmm	Steckdicke	Steckbreite	a1	a2	l1	l2	Mat.-dicke	Form E=Einzel B=Band	Teile-Nr.	Werkstoff	Oberfläche	Verb.-vor-schub

Einzelkontakte auf Anfrage



**Tabs**  
with tab width 2.8 mm  
to engage in housings  
DIN 46343 and similar types

**Flachstecker**  
mit Steckerbreite 2,8 mm  
zum Einrasten in Gehäuse  
DIN 46343 und ähnliche Ausführungen

Type 1

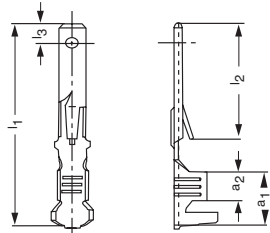

Type 2

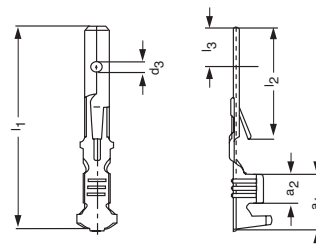

Type	Wire cross section qmm	Tab thickness	Tab width	DIN standard	Nominal size	a1	a2	d3	l1	l2	l3	Material thickness	Form E=single B=chain	Part number	Material	Surface	Terminal feed	Foot-note
2	0.5 - 1.0	0.80	2.8	46343 Teil 1 Form B	2.8 - 1.0	6.00	3.20	1.30	22.50	12.70	2.20	0.38	E	05628.123.011	CuZn	Sn		
													E	05628.213.011	CuSn	Sn		
													B	25628.123.009	CuZn		L	
													B	25628.213.009	CuSn	Sn		
1	0.2 - 0.4	0.80	2.8			6.00	3.20		22.50	12.70	2.20	0.38	B	25617.123.111	CuZn	Sn	L	
1	0.75 - 1.5	0.80	2.8			6.00	3.20		22.50	12.70	2.20	0.38	B	25618.123.111	CuZn	Sn	L	
1	0.5 - 1.0	0.80	2.8			6.00	3.20		22.50	12.70		0.38	B	25620.123.111	CuZn	Sn	L	*1
													B	25620.213.009	CuSn	Sn		*1
1	0.2 - 0.4	0.80	2.8			6.00	3.20		22.50	12.70		0.38	B	25660.123.111	CuZn	Sn	L	*1
2	0.5 - 1.0	0.80	2.8			6.00	3.20	1.20	22.50	12.70	4.50	0.38	B	25818.213.178	CuSn	Sn	L	
1	0.75 - 1.5	0.80	2.8			6.00	3.20		22.50	12.70		0.38	B	25990.123.111	CuZn	Sn	L	*1
2	0.5 - 1.0	0.80	2.8			6.00	3.20		22.50	12.70		0.38	B	26342.123.111	CuZn	Sn	L	*1
Typ	Nenn-quer-schnitt qmm	Steck-dicke	Steck-breite	DIN	Nenn-größe	a1	a2	d3	l1	l2	l3	Mat-dicke	Form E=Einzel B=Band	Teile-Nr.	Werkstoff	Oberfläche	Verb.-vor-schub	Fuß-note

\* Without Locking hole

\* Ohne Rastloch

Einzelkontakte auf Anfrage

## Tabs

with tab width 2.8 mm  
to engage in housings

## Flachstecker

mit Steckerbreite 2,8 mm  
zum Einrasten in Gehäuse

Type 1

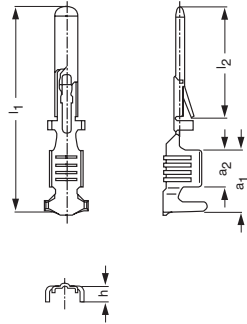

Type 2

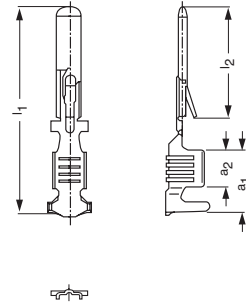

Type	Wire cross section qmm	Type of Lead	Insulation diameter	Tab thickness	Tab width	a1	a2	l1	l2	h	Material thickness	Form E=Single B=chain	Part number	Material	Surface	Terminal feed	Foot-note
2	0.5 -1.0 (0.35)	FL	1.4 - 2.1	0.80	2.80	6.20	3.00	22.50	12.10		0.38	B	<b>26043.201.702</b>	CuSn	Ni/Sn/Ni/Au	NQ	*1
1	0.5 -1.0 (0.35)	FL	1.4 - 2.1	0.80	2.80	6.20	3.00	22.50	12.10	1.90	0.38	B	<b>26165.201.178</b>	CuSn	Sn	NQ	*1
1	1.5 - 2.5	FL	2.2 - 3.0	0.80	2.80	7.20	4.00	22.50	12.10	1.90	0.38	B	<b>26166.201.178</b>	CuSn	Sn	NQ	*1
Typ	Nennquerschnitt qmm	Leitart	Isol.-Ø	Steckdicke	Steckbreite	a1	a2	l1	l2	h	Mat.-dicke	Form E=Einzel B=Band	Telle-Nr.	Werkstoff	Oberfläche	Verb.-vorschub	Fußnote

\*1 The terminals have different kinds of strips

\*1 Die Kontakte besitzen unterschiedliche Transportstreifen

Einzelkontakte auf Anfrage

## Tabs PLUS

to engage in housings  
for splash-proof version

## Flachstecker PLUS

zum Einrasten in Gehäuse  
für spritzwassergeschützten Einsatz

Type 1

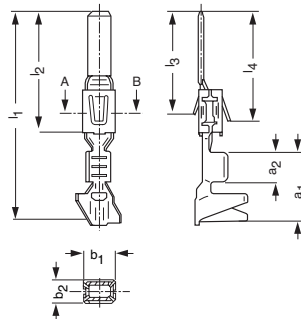

Type	Wire cross section qmm	Insulation diameter	Tab thickness	Tab width	a1	a2	b1	b2	l1	l2	l3	l4	Mat- erial thick- ness	Steel spring	Form E=single B=chain	Part number	Material	Surface	Ter- minal feed	Foot- note
1	0.5 - 1.0	1.4 - 2.0	0.80	2.80	8.80	3.50	2.80	3.95	26.00	15.00	12.60	13.5	0.38	X	B B	<b>26253.201.702</b> <b>26253.331.178</b>	CuSn CuFe2P	Ni/Sn/Ni/Au Sn	NQ	*1
1	1.5 - 2.5	2.1 - 2.9	0.80	2.80	8.80	3.50	2.80	3.95	26.00	15.00	12.60	13.5	0.38	X	B	<b>26255.331.178</b>	CuFe2P	Sn	NQ	*1
Typ	Nenn- quer- schnitt qmm	Isol.- Ø	Steck- dicke	Steck- breite	a1	a2	b1	b2	l1	l2	l3	l4	Mat- dicke	Stahl- feder	Form E=Einzel B=Band	Teile-Nr.	Werkstoff	Oberfläche	Verb.- vor- schub	Fuß- note

## Tabs

with tab width 2.8 mm  
to engage in housings

## Flachstecker

mit Steckerbreite 2,8 mm  
zum Einrasten in Gehäuse

Type 1

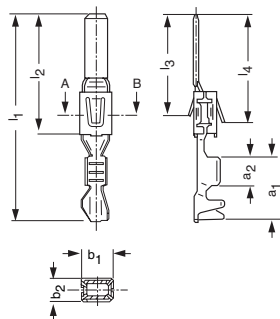

Type	Wire cross section qmm	Insulation diameter	Tab thickness	Tab width	a1	a2	b1	b2	l1	l2	l3	l4	Mat- erial thick- ness	Steel spring	Form E=single B=chain	Part number	Material	Surface	Ter- minal feed	Foot- note
1	0.5-1.0	1.4-2.0	0.80	2.80	8.00	3.50	2.80	3.95	26.00	15.00	12.60	13.50	0.38	X	B	<b>26252.331.178</b>	CuFe2P	Sn	NQ	*1
1	1.5-2.5	2.1-2.9	0.80	2.80	8.00	3.50	2.80	3.95	26.00	15.00	12.60	13.50	0.38	X	B	<b>26254.331.178</b>	CuFe2P	Sn	NQ	*1
Typ	Nenn- quer- schnitt qmm	Isol.- Ø	Steck- dicke	Steck- breite	a1	a2	b1	b2	l1	l2	l3	l4	Mat- dicke	Stahl- feder	Form E=Einzel B=Band	Teile-Nr.	Werkstoff	Oberfläche	Verb.- vor- schub	Fuß- note

Einzelkontakte auf Anfrage





## Tabs

with tab width **2.8 mm**  
to engage in housings  
flag type

## Flachstecker

mit Steckerbreite **2,8 mm**  
zum Einrasten in Gehäuse  
mit seitlichem Leiteranschluß

Type 1

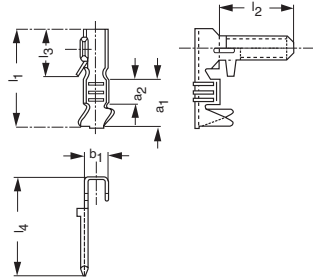

Type	Wire cross section gmm	Tab thickness	Tab width	a1	a2	b1	l1	l2	l3	l4	Material thickness	Form E=single B=chain	Part number	Material	Surface	Terminal feed
1	0.75	0.80	2.80	6.00	3.20	3.00	12.20	9.50	6.10	12.50	0.38	B	<b>26058.123.178</b>	CuZn	Sn	NQ
Typ	Nennquerschnitt gmm	Steckdicke	Steckbreite	a1	a2	b1	l1	l2	l3	l4	Mat-dicke	Form E=Einzel B=Band	Teile-Nr.	Werkstoff	Oberfläche	Verb.vorschub

**Tabs**  
with tab width **2.8 mm**

**Flachstecker**  
mit Steckerbreite **2,8 mm**

Type 1

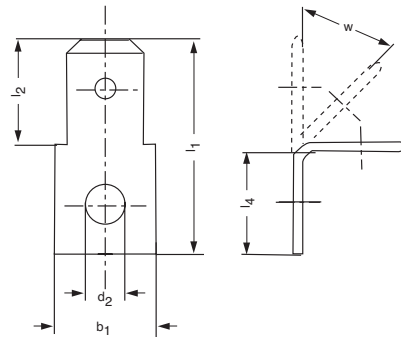

Type	Tab thickness	Tab width	b1	d2	l1	l2	l4	W°	Material thickness	Form E=single B=chain	Part number	Material	Surface
1	0.80	2.80	4.50	3.10	13.00	5.50	6.50	90	0.80	E	12464.123.011	CuZn	Sn
1	0.80	2.80	4.50	3.10	13.00	5.50	6.50	60	0.80	E	12694.123.011	CuZn	Sn
Typ	Steckdicke	Steckbreite	b1	d2	l1	l2	l4	W°	Mat-dicke	Form E=Einzel B=Band	Teile-Nr.	Werkstoff	Oberfläche

## Tabs

with tab width **2.8 mm**

## Flachstecker

mit Steckerbreite **2,8 mm**

Type 1

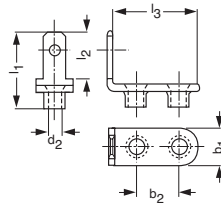

Type	Tab thickness	Tab width	b1	b2	d2	l1	l2	l3	Material thickness	Form E=Single B=chain	Part number	Specification	Material	Surface
1	0.80	2.80	4.50	5.00	1.80	9.00	5.50	9.75	0.80	E	<b>12003.111.011</b>	Flachstecker	CuZn	Sn
Typ	Steckdicke	Steckbreite	b1	b2	d2	l1	l2	l3	Mat.-dicke	Form E=Einzel B=Band	Teile-Nr.	Bezeichnung	Werkstoff	Oberfläche

## Tabs

with tab width **2.8 mm**  
for soldering into PC boards

Type 1

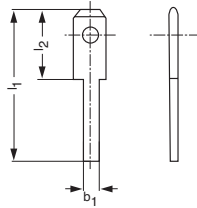

Type 2

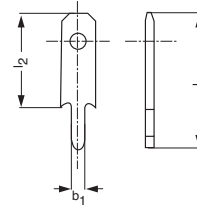

Type 3

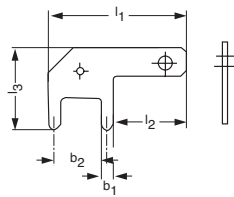

Type 4

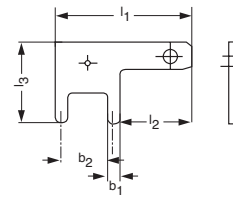

Type	Tab thickness	Tab width	b1	b2	l1	l2	l3	Material thickness	Form E=single B=chain	Part number	Material	Surface
2	0.80	2.80	0.90		10.50	6.50		0.80	E	<b>12610.123.025</b>	CuZn	Sn
2	0.80	2.80	0.90		11.50	8.10		0.80	E	<b>12625.123.011</b>	CuZn	Sn
4	0.80	2.80	1.30	5.00	13.40	7.10	8.00	0.80	E	<b>17124.123.025</b>	CuZn	Sn
3	0.80	2.80	1.30	5.00	13.40	7.10	8.00	0.80	E	<b>17127.123.025</b>	CuZn	Sn
1	0.80	2.80	1.40		14.00	6.50		0.80	E	<b>17486.123.025</b>	CuZn	Sn
Typ	Steckdicke	Steckbreite	b1	b2	l1	l2	l3	Mat.-dicke	Form E=Einzel B=Band	Teile-Nr.	Werkstoff	Oberfläche

**Multiple tabs**  
with tab width 2.8 mm

**Steckverteiler**  
mit Steckerbreite 2,8 mm

Type 1

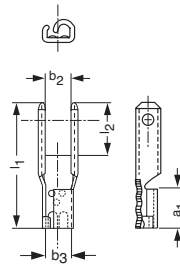

Type	Tab thickness	Tab width	a1	b2	b3	l1	l2	Material thickness	Notch	Form E=single B=chain	Part number	Material	Surface
1	0.80	2.80	5.00	3.20	3.10	16.00	6.70	0.38	X	E	17447.123.211	CuZn	Sn
Typ	Steckdicke	Steckbreite	a1	b2	b3	l1	l2	Mat.-dicke	Rastpunkt	Form E=Einzel B=Band	Teile-Nr.	Werkstoff	Oberfläche

## Housings

for receptacles  
with tab width **2.8 mm**

## Gehäuse

für Flachsteckhülsen  
Steckerbreite **2,8 mm**

Type 1

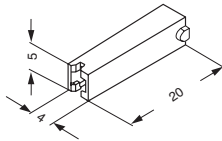

Type 2

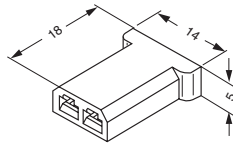

Type 3

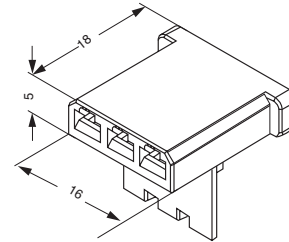

Type	No. of ways	Pitch	Part number	Specification	Material	Colour
3	3	5.00	16314.562.501	Flachsteckhülsegehäuse	PA66	natur
2	2		16341.562.501	Flachsteckhülsegehäuse	PA66	natur
1	1		16802.635.501	Flachsteckhülsegehäuse	PA66	natur
Typ	Polzahl	Raster	Teile-Nr.	Bezeichnung	Werkstoff	Farbe

Type 1

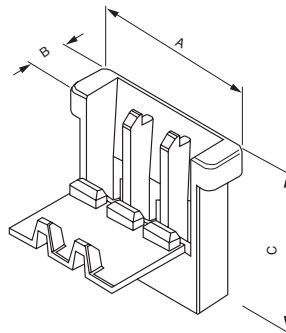

Type	A	B	C	Part number	Specification	Material	Surface
1	19.2	5	18	13183.562.699	FSH 2,8-Gehäuse	PA66	schwarz
Typ	A	B	C	Teile-Nr.	Bezeichnung	Werkstoff	Oberfläche

**Housings**  
for tabs  
with tab width **2.8 mm**

**Gehäuse**  
für Flachstecker  
mit Steckerbreite **2,8 mm**

Type 1

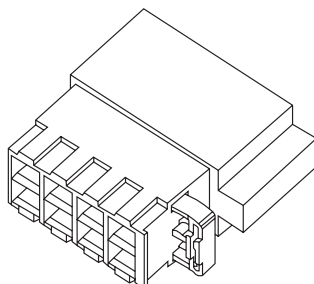

Type	No. of ways	Part number	Specification	Material	Colour
1	8	17776.000.000	Flachsteckergehäuse Verriegelungsschieber Flachsteckergehäuse	PA + PE PA	fehgrau tiefschwarz
Typ	Polzahl	Teile-Nr.	Bezeichnung	Werkstoff	Farbe

## Tab-coupling

tab width 2.8 mm

## Flachstecker-Kupplung

Steckerbreite 2,8 mm

Type 1

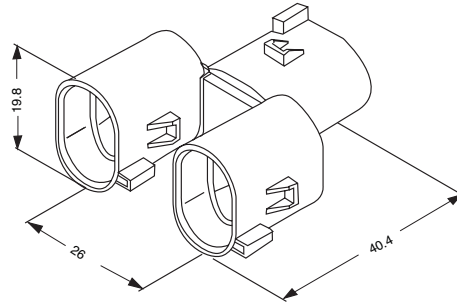

Type	No. of ways	Part number	Specification
1	2/4	18135.000.000	Kupplung
Typ	Pol.-zahl	Teile-Nr.	Bezeichnung